

Article number: 5725027216

Description: NSK Cirkular flange unit UCFC216D1

Measures

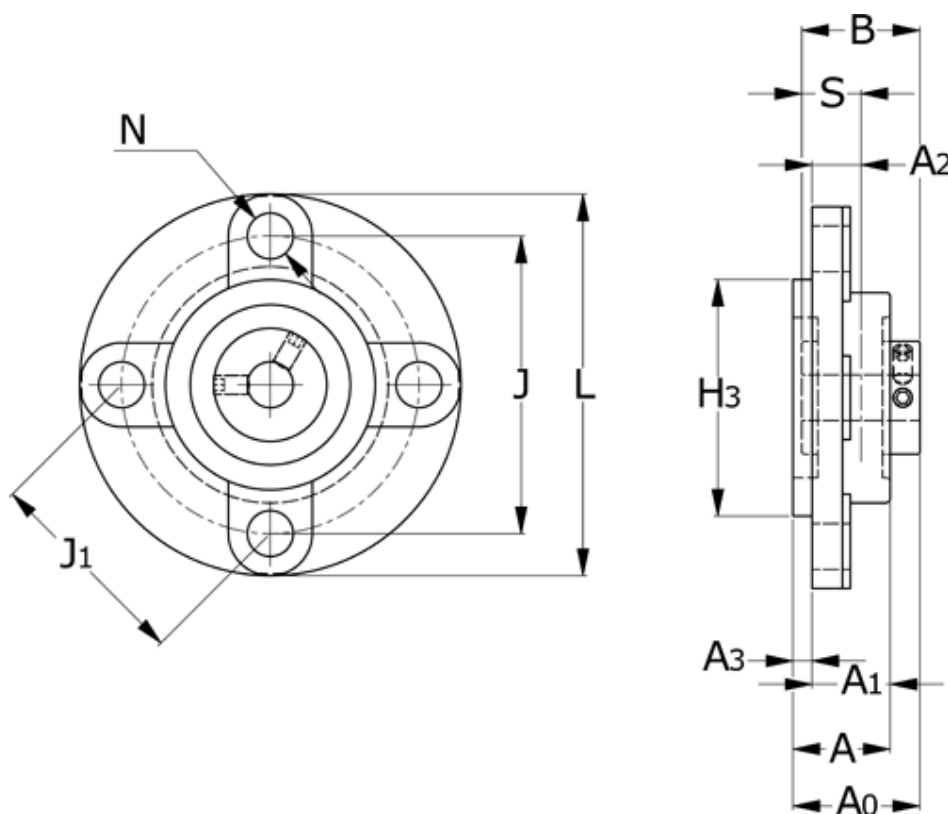

A = 58	J1 = 141.4
A0 = 83.3	L = 240
A1 = 42	N = 23
A2 = 18	S = 33.3
A3 = 16	Shaft = 80
B = 82.6	
H3 = 170	
J = 200	